

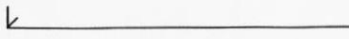





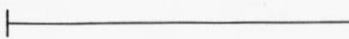
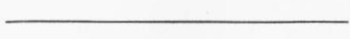

# Grow Tent Instructions 1

A 200 x 200

## PART LIST : Grow Tent

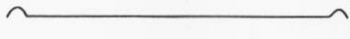
	<b>B</b> x4		<b>A</b> x4
	<b>B</b> x2		<b>A</b> x3
	<b>C</b> x4		<b>A</b> x4
	<b>C</b> x2		<b>09</b> x4
	<b>A</b> x2		<b>10</b> x2

## ASSEMBLY : Grow Tent

1. Lay out Grow Tent making sure all the zips are completely undone, this piece is for the bottom section.

Assemble the tent frame as detailed.

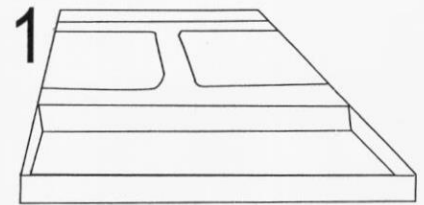

2. Insert poles #A and #A to each #B and #B connector on the other two ways as picture 2 shown.
3. Insert poles #A and #A to each #C and #C connector on the other two ways as picture 3 shown.
4. Connect the two parts when you have finished step 2 and 3 as picture 4 shown, you'd better do this with other 3 people.

Now you have finished the assembling of the frame.

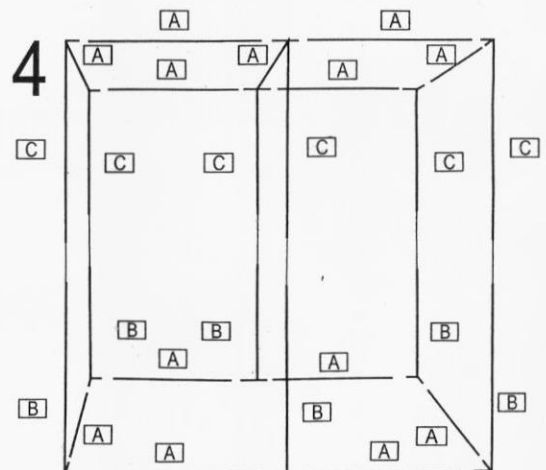
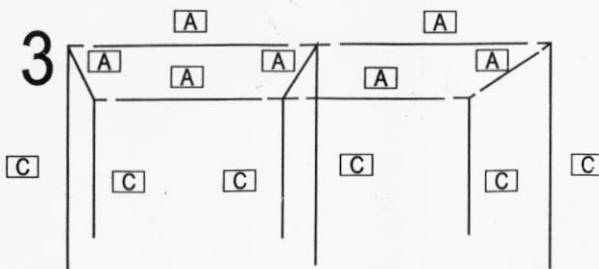
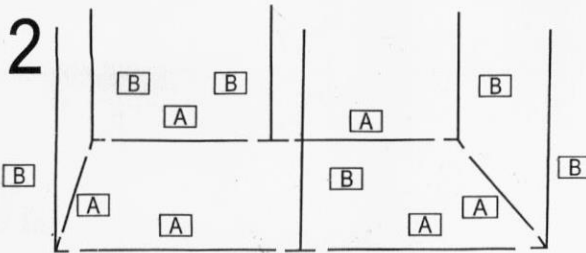

# Grow Tent Instructions 2

A 200 x 200

5. Put on the canvas to the frame from the bottom as picture 5 shown, and then the back side, make sure the canvas is unzipped.

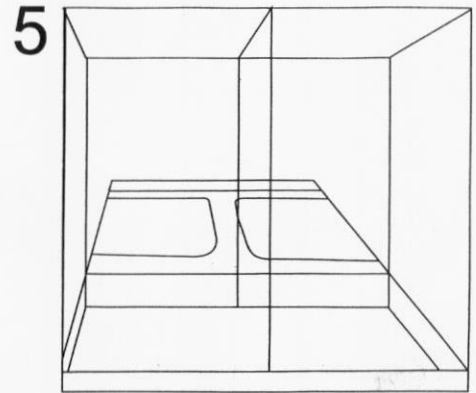

6. Put on the top part of the canvas then form the right to the front.

7. Close the zip form the right side to the front side, same as step 6.

8. Now we have finished assembling the vanvas as picture 8.

6

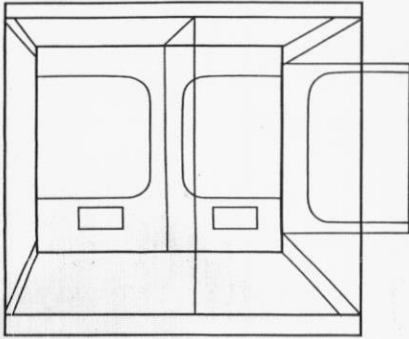

7

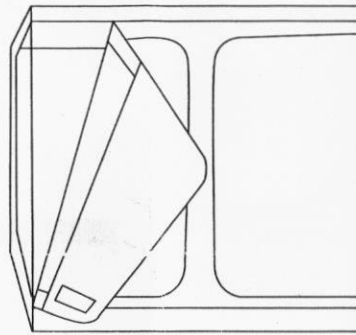

8

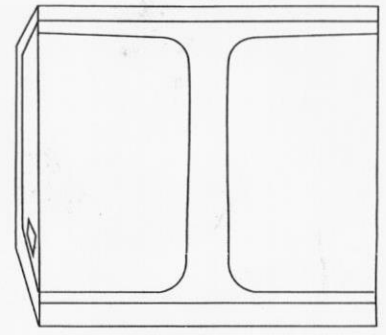

9. Open the two front door.

10. Put poles #09 and #10 on the top of the frame as pic8.

11. Insert the Grow Tent tray liner and attach to with

Cabel tie fastening to pole. All parts have been assembled.

12. Close all the zippers and make final adjustments to the canopy.

9

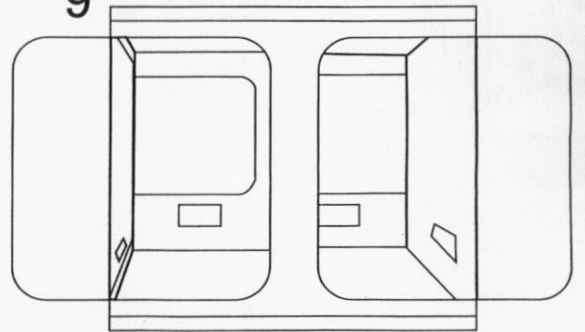

10

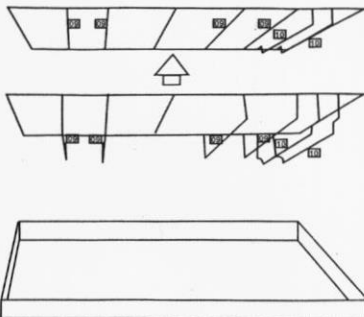

11

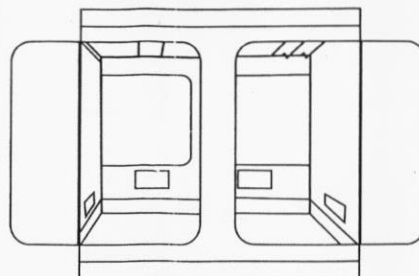

12

